

CSE 332
INTRODUCTION TO VISUALIZATION
INTERACTION & INFORMATION
NAVIGATION

KLAUS MUELLER

COMPUTER SCIENCE DEPARTMENT
STONY BROOK UNIVERSITY

Lecture	Topic	Projects
1	Intro, schedule, and logistics	
2	Applications of visual analytics, data, and basic tasks	
3	Data preparation and reduction	Project 1 out
4	Data preparation and reduction	
5	Data reduction and similarity metrics	
6	Dimension reduction	
7	Introduction to D3	Project 2 out
8	Bias in visualization	
9	Perception and cognition	
10	Visual design and aesthetics	
11	Cluster and pattern analysis	
12	High-Dimensional data visualization: linear methods	
13	High-D data vis.: non-linear methods, categorical data	Project 3 out
14	Principles of interaction	
15	Visual analytics and the visual sense making process	
16	VA design and evaluation	
17	Visualization of graphs and hierarchies	
18	Visualization of time-varying and time-series data	Project 4 out
19	Midterm	
20	Maps and geo-vis	
21	Computer graphics and volume rendering	
22	Techniques to visualize spatial (3D) data	Project 4 halfway report due
23	Scientific and medical visualization	
24	Scientific and medical visualization	
25	Non-photorealistic rendering	
26	Memorable visualizations, visual embellishments	Project 5 out
27	Infographics design	
28	Projects Hall of Fame demos	

Too Much Data?

How can we deal with data overload

- see the forest for the trees (or the other way around)

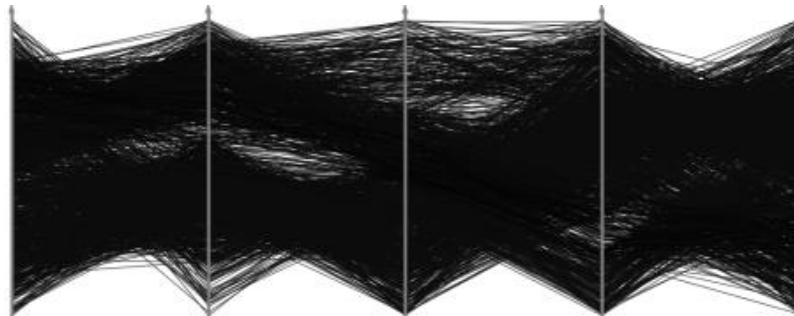
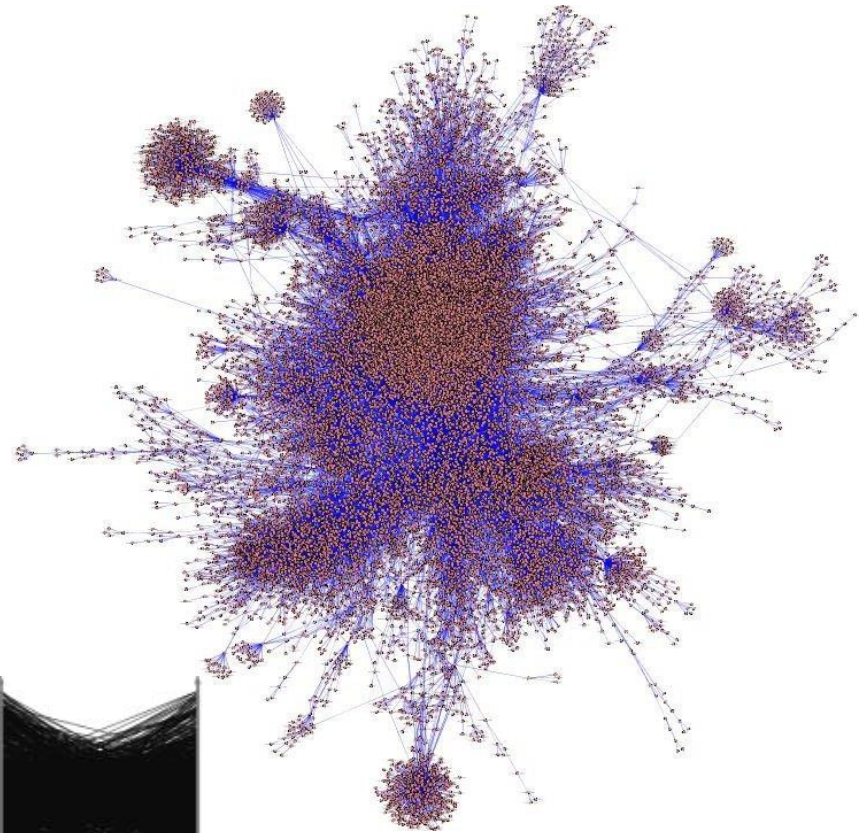
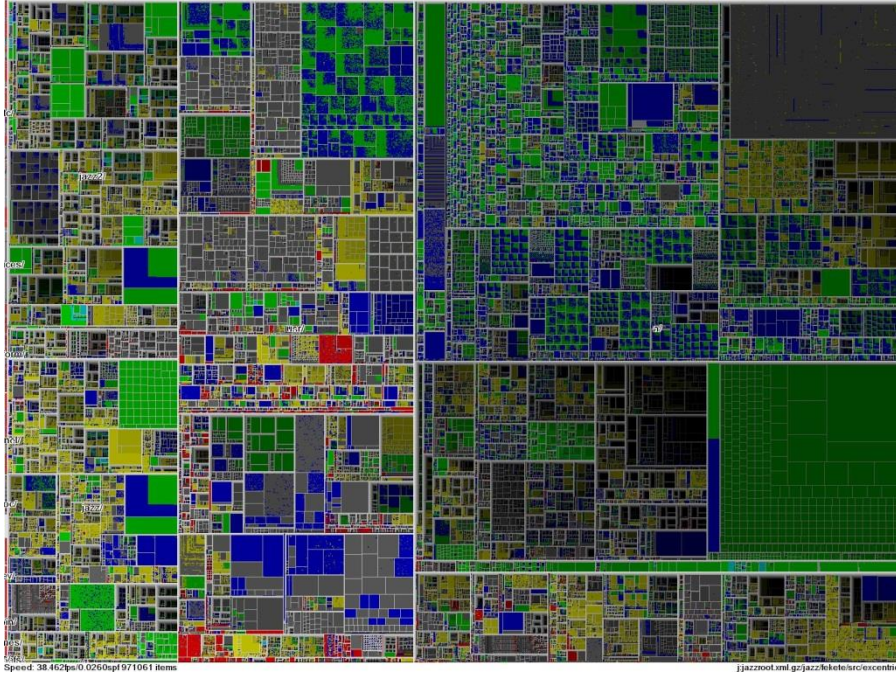

Too Much Data?

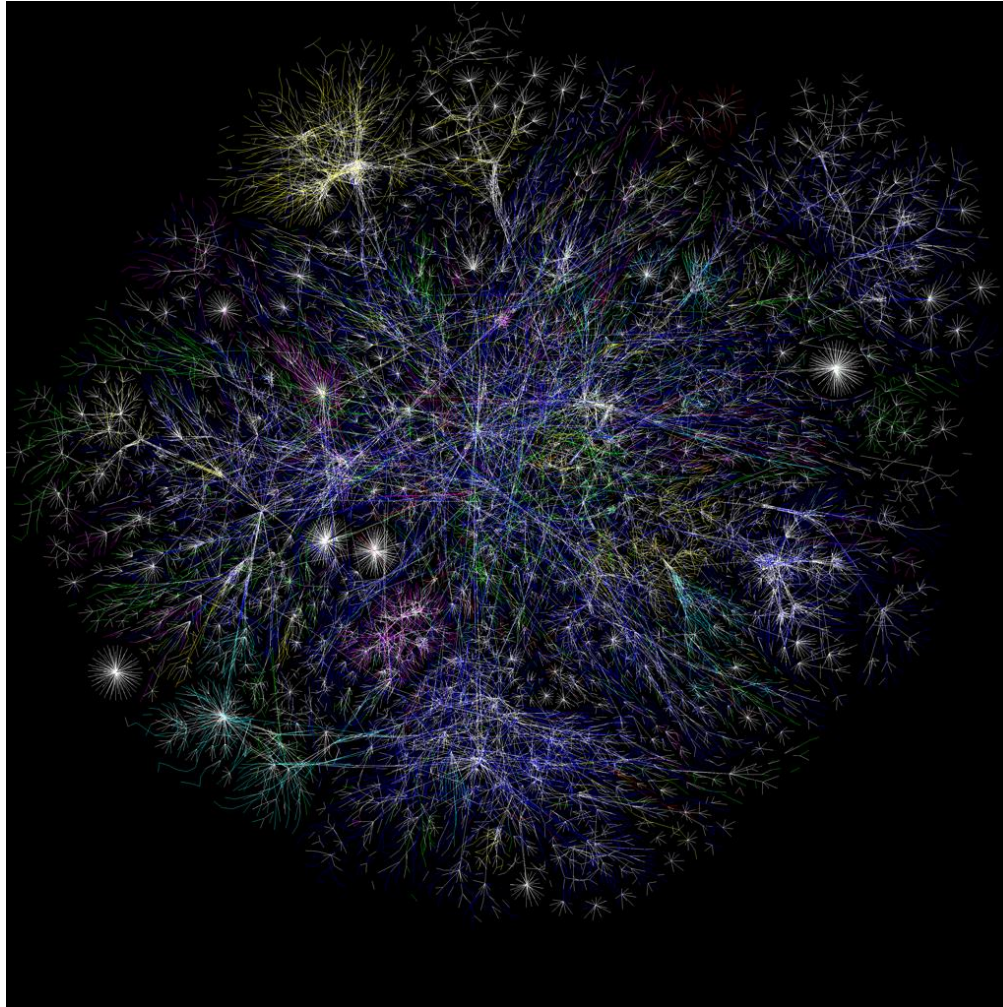

Internet routes (1/15/2005)

(NY Museum of Modern Art)

The Key to Overcome the Data Deluge: Interaction

Allow users to control what is currently shown:

- level of detail
- extent of the data (spatial, values)
- aspects of the data (attributes)

But do not leave the user lost in the forest

- provide navigation hints

Two powerful paradigms:

- overview, and detail on demand (forest and trees)
- focus and context (trees and forest)

Interaction needs to be interactive (as in responsive)

- user needs get quick visual feedback on actions

Interaction: Key to Visual Analytics

Puts the human in the loop

- appeals to human's expertise and intuition

Requires a suitable human-computer interface

- recall the lectures on color and perception

Interaction can help with:

- making sense of it all
- putting things in proper context
- data overload (scalability)
- telling stories with data (explain findings to others)

Evaluate effectiveness

- do human users actually benefit?
- user studies!

A Taxonomy of Fundamental Interaction Types

Stephen Few (chapter 4):

- compare and contrast
- sort
- add variables
- re-scale
- re-express
- filter
- highlight
- annotate
- bookmark
- aggregate
- re-visualize
- zoom and pan
- details on demand

Example

Assume you have been offered a car to buy

- assume you are mostly interested in horsepower, weight, acceleration
- the car you have been offered has 60 hp, 1834 kg, 8 s

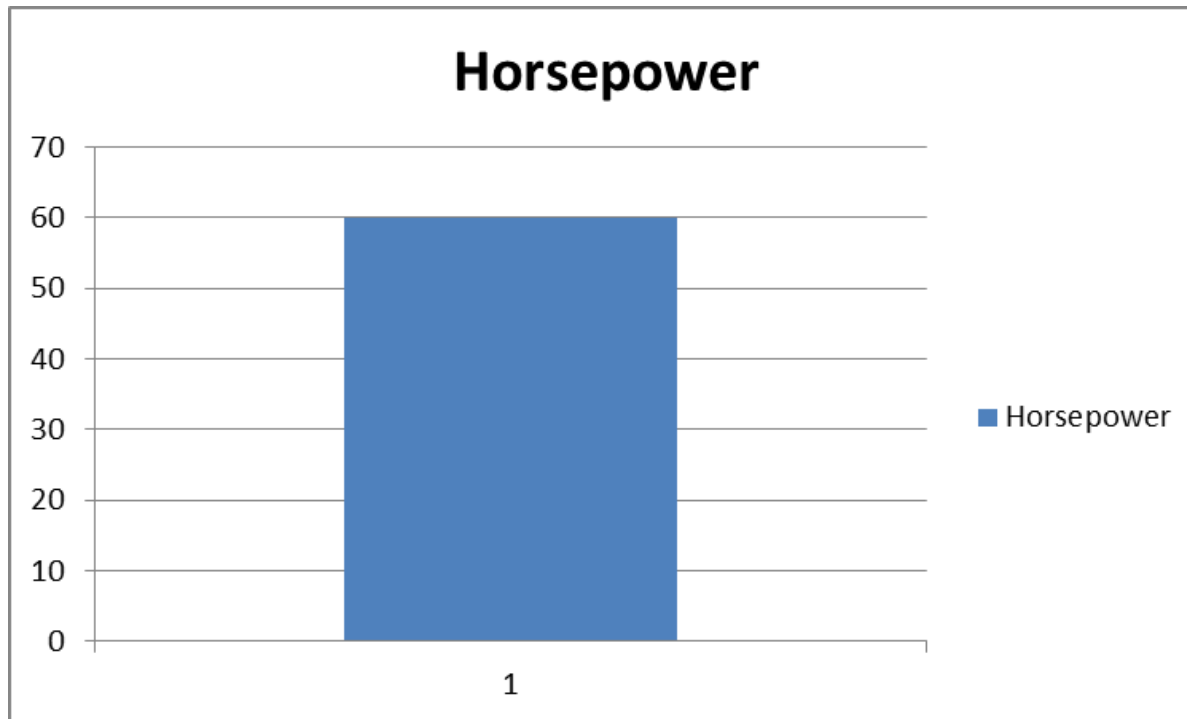

Compare and Contrast

See the car with other available cars

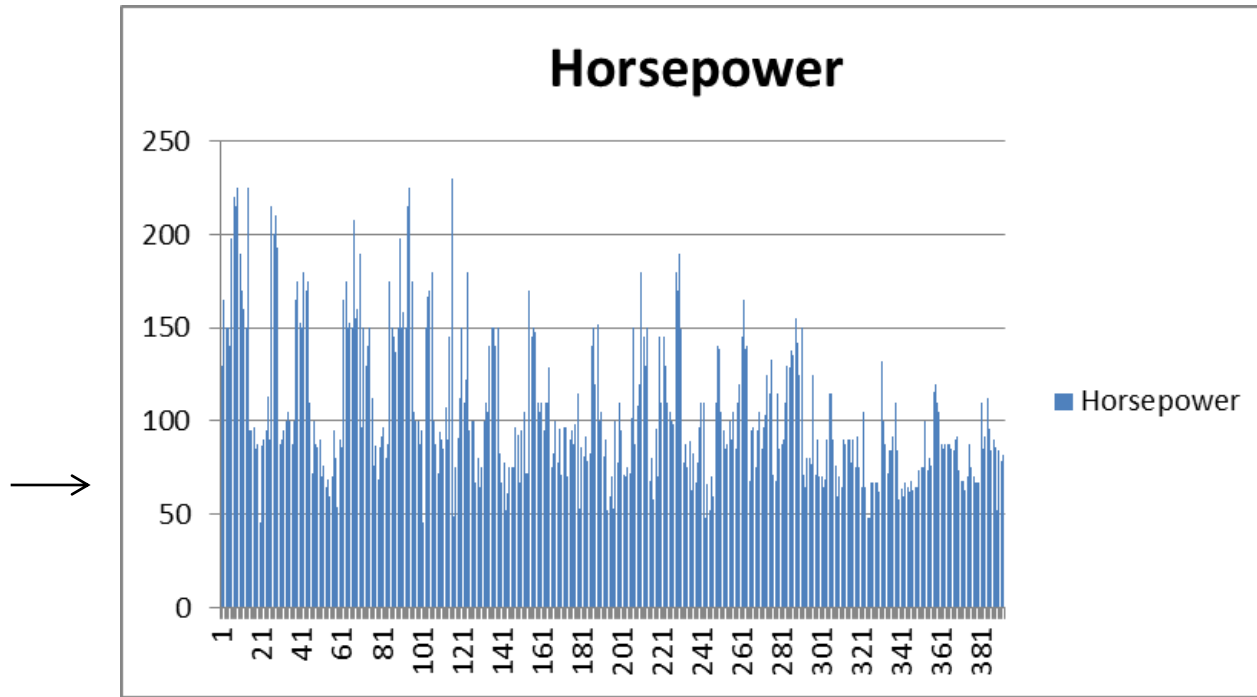

hard to see how it really ranks

Sort

See the car in the context of other available cars

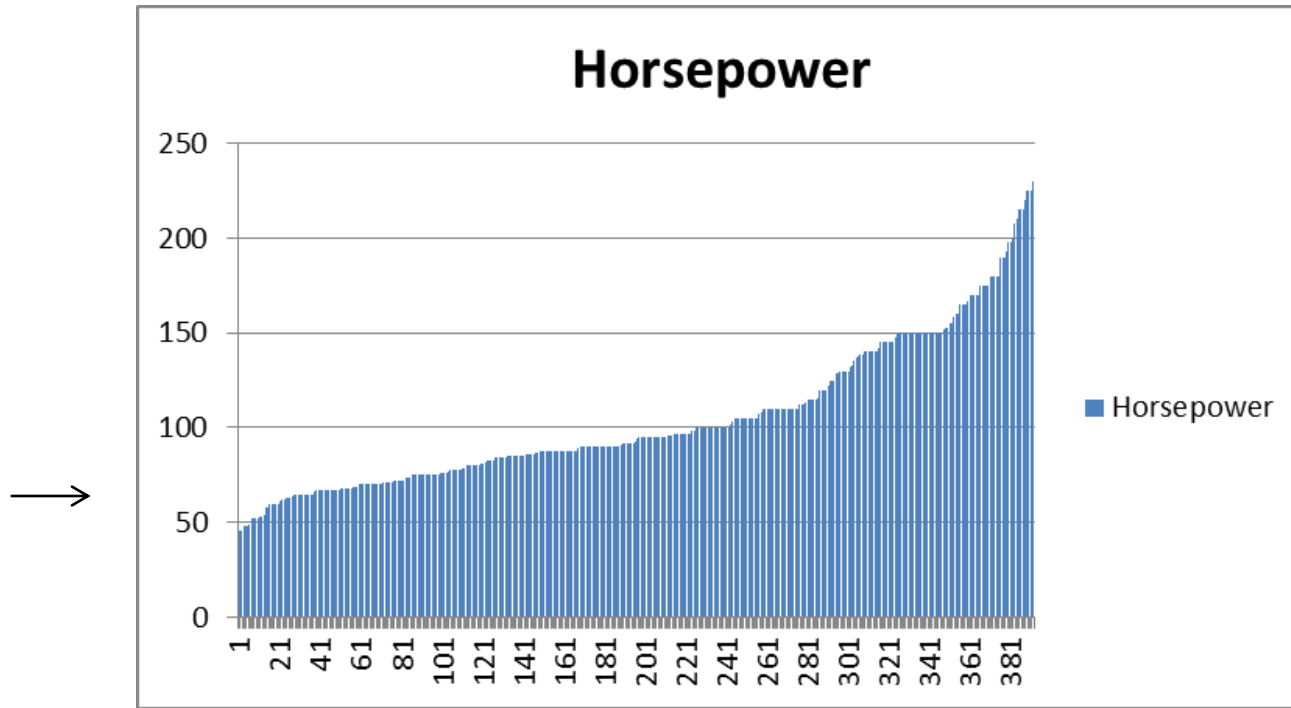

it is a low-horsepower car

Additional Variables

Is horsepower correlated to weight?

- are there trade-offs?

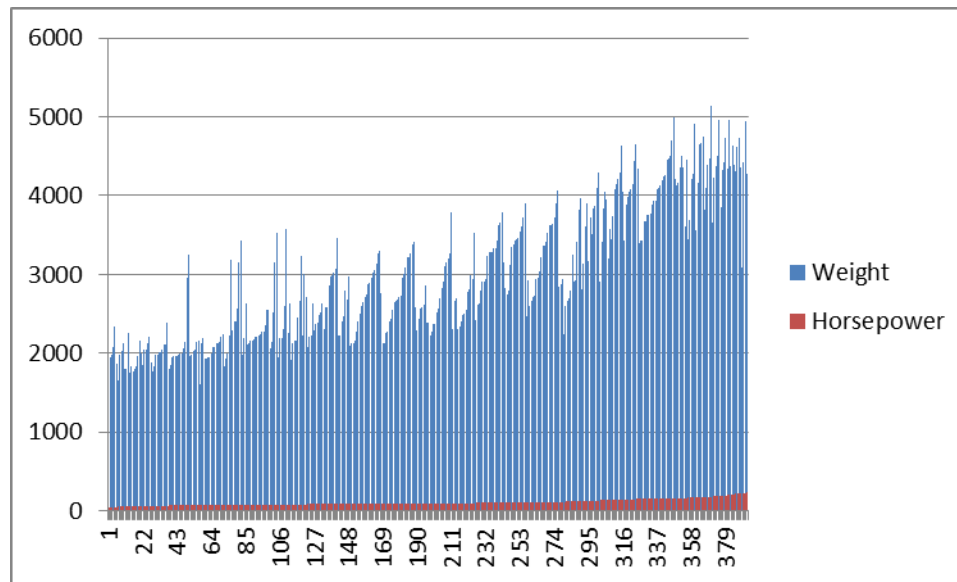

hard to see what is going on

Re-Scale

Scale horsepower into the same range than weight

- could also normalize each to (0.0, 1.0)

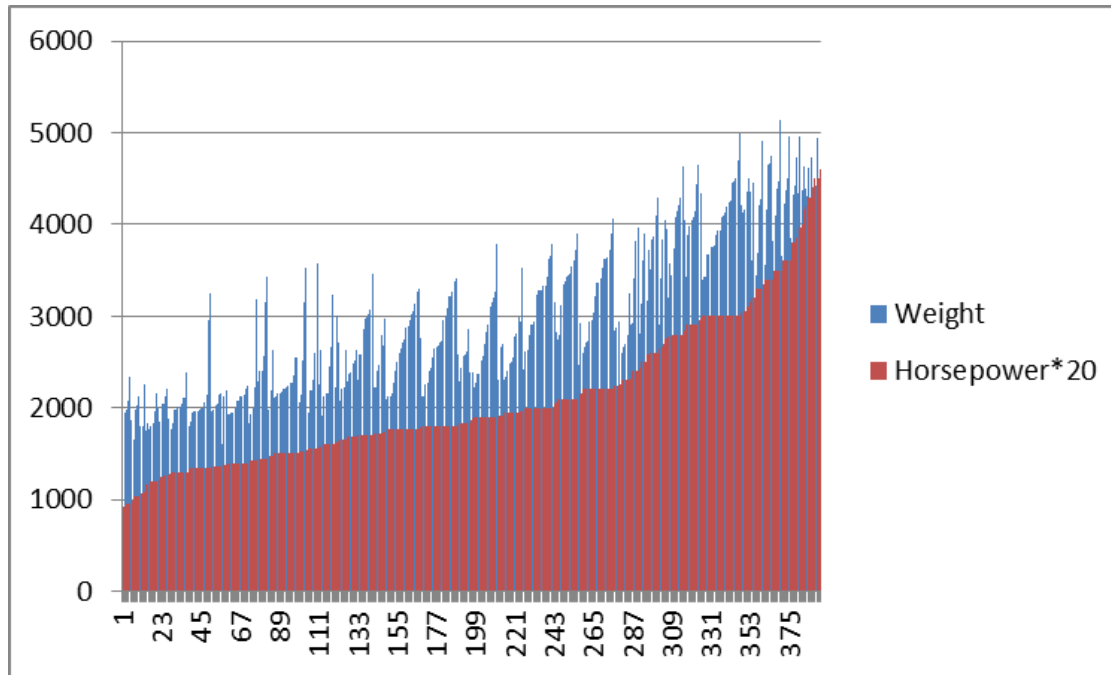

There seems to be a positive correlation

- cars with higher horsepower are also heavier

Another Variable

How does it relate to acceleration?

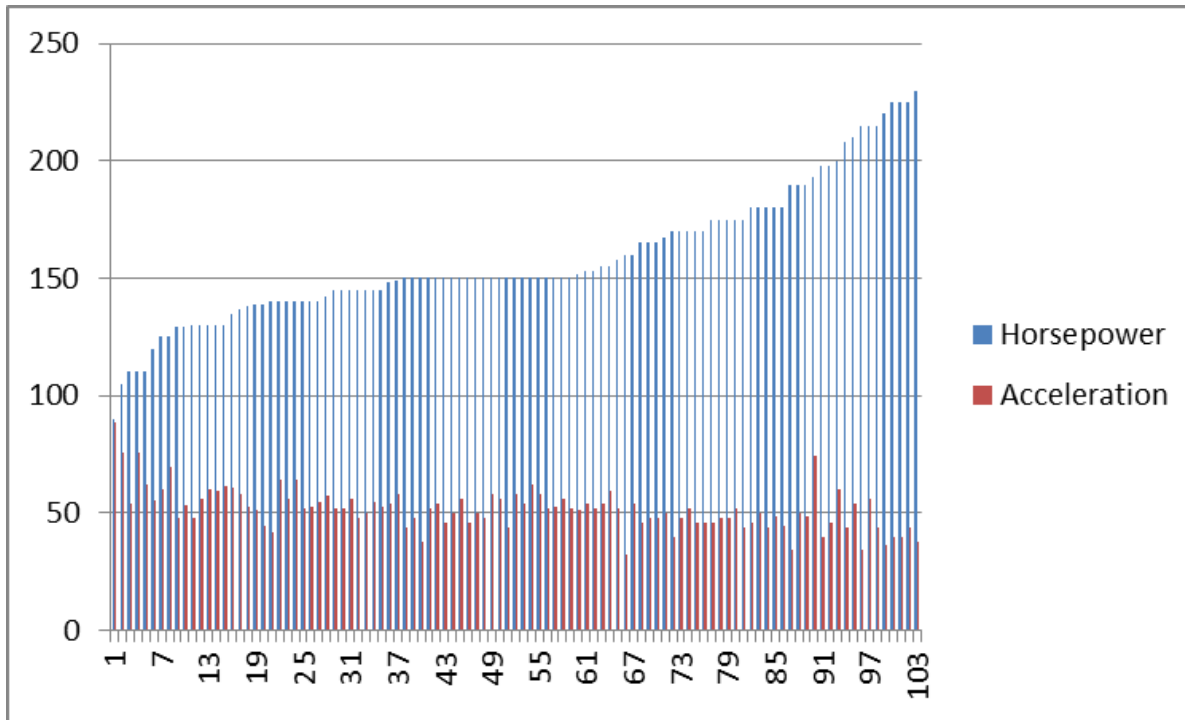

non-intuitive that acceleration is less for high horsepower cars

Re-Express

Acceleration should really be $1/\text{acceleration}$

- should be measured in $1/\text{sec}$ (and not sec)

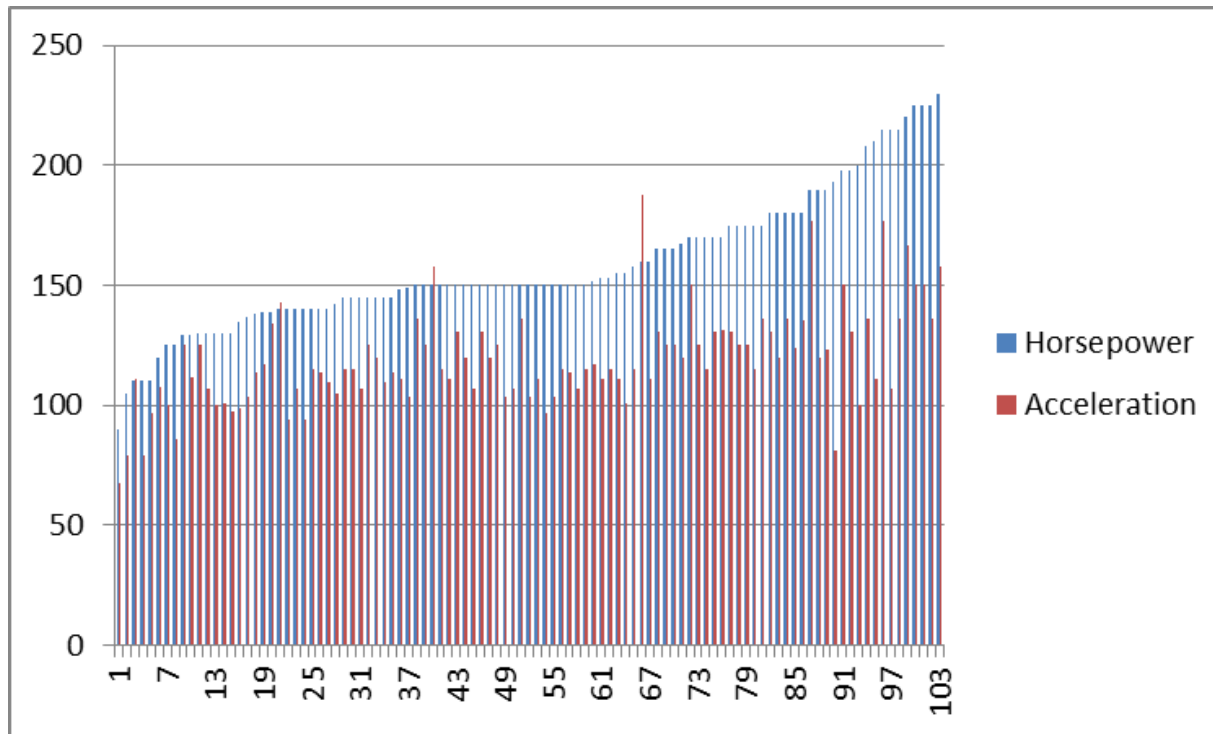

- now higher horsepower cars also seem to have higher acceleration (but the influence is quite minor) → is there a higher-D relationship?

Filtering

Example: Graph of concepts

- related concepts group closer

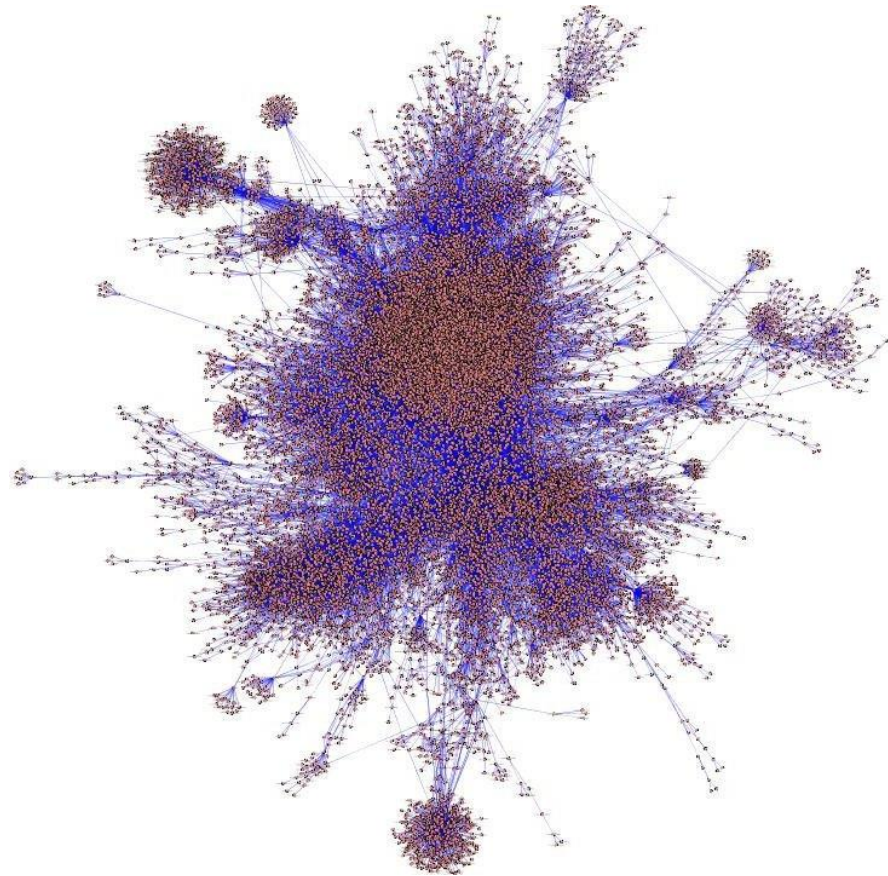

Filtering

Example: Graph of concepts

- only keep top 750 connected nodes

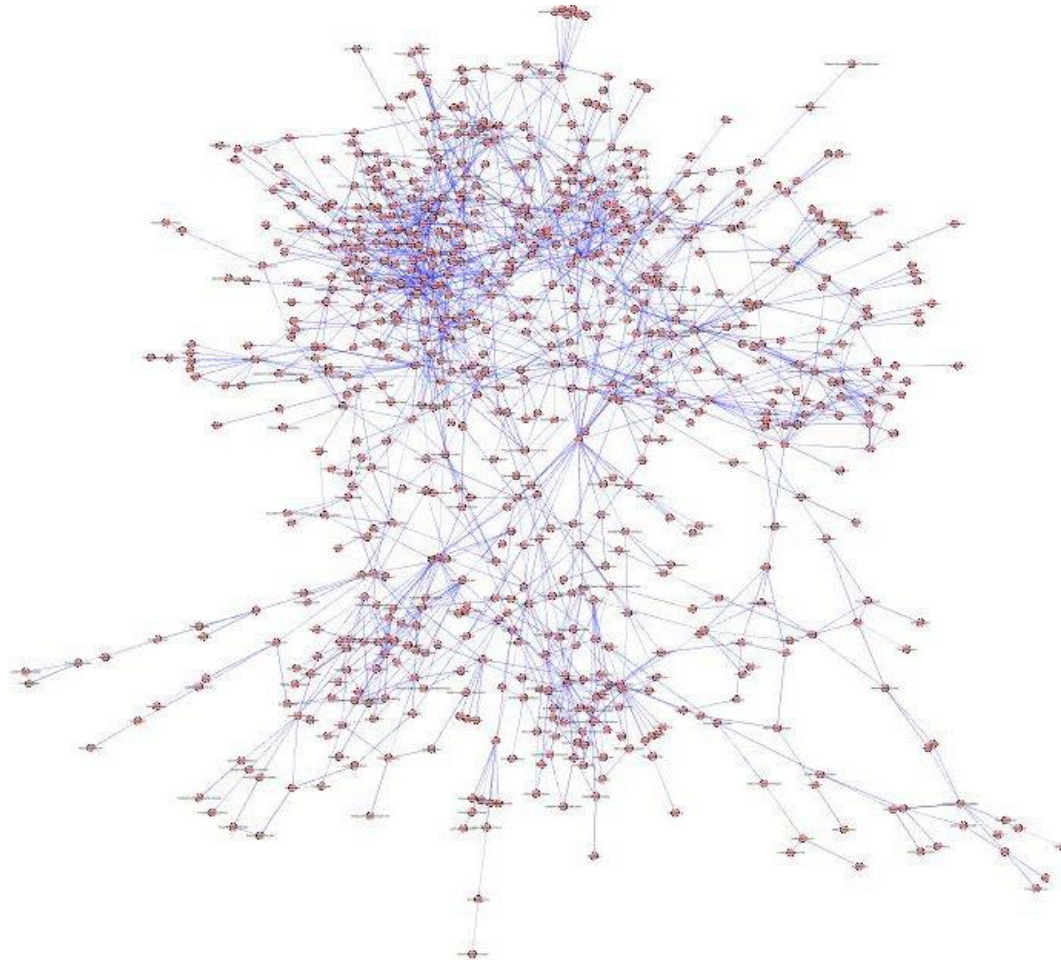

Filtering

Example: Graph of concepts

- only keep top 350 connected nodes

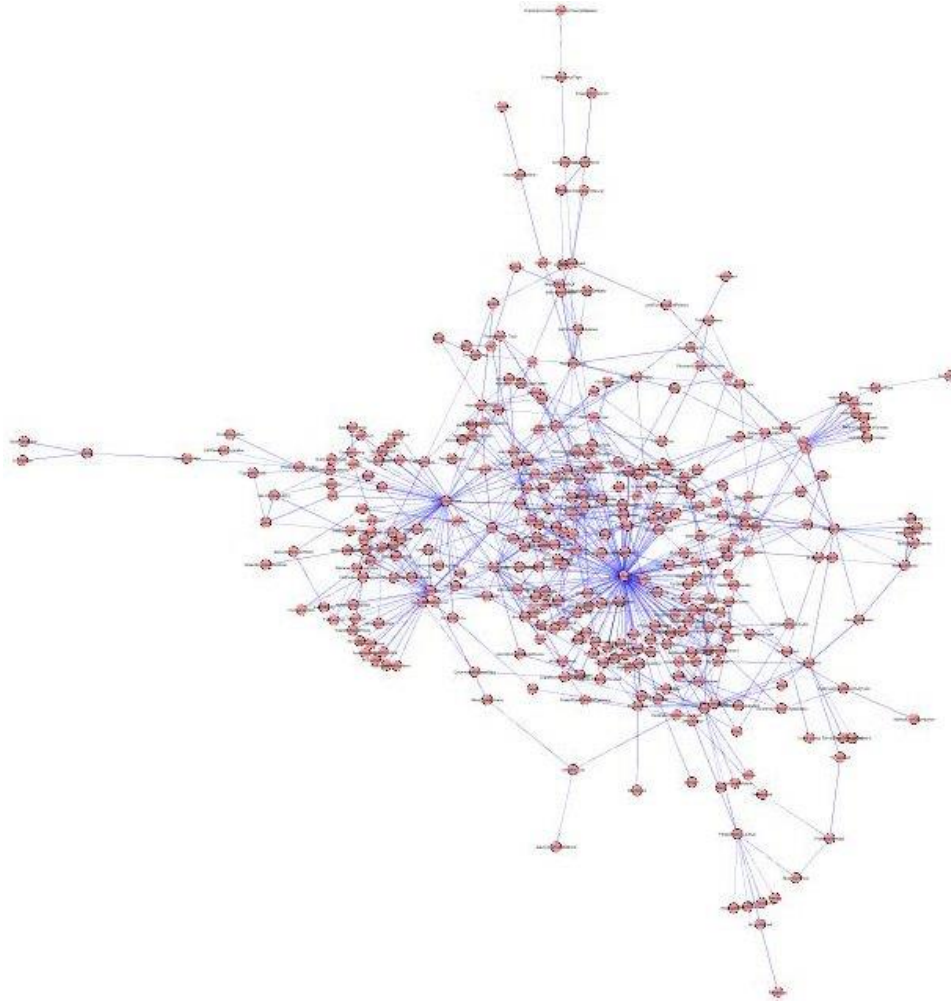

Zooming

Example: Graph of concepts

- only keep Saab neighborhood

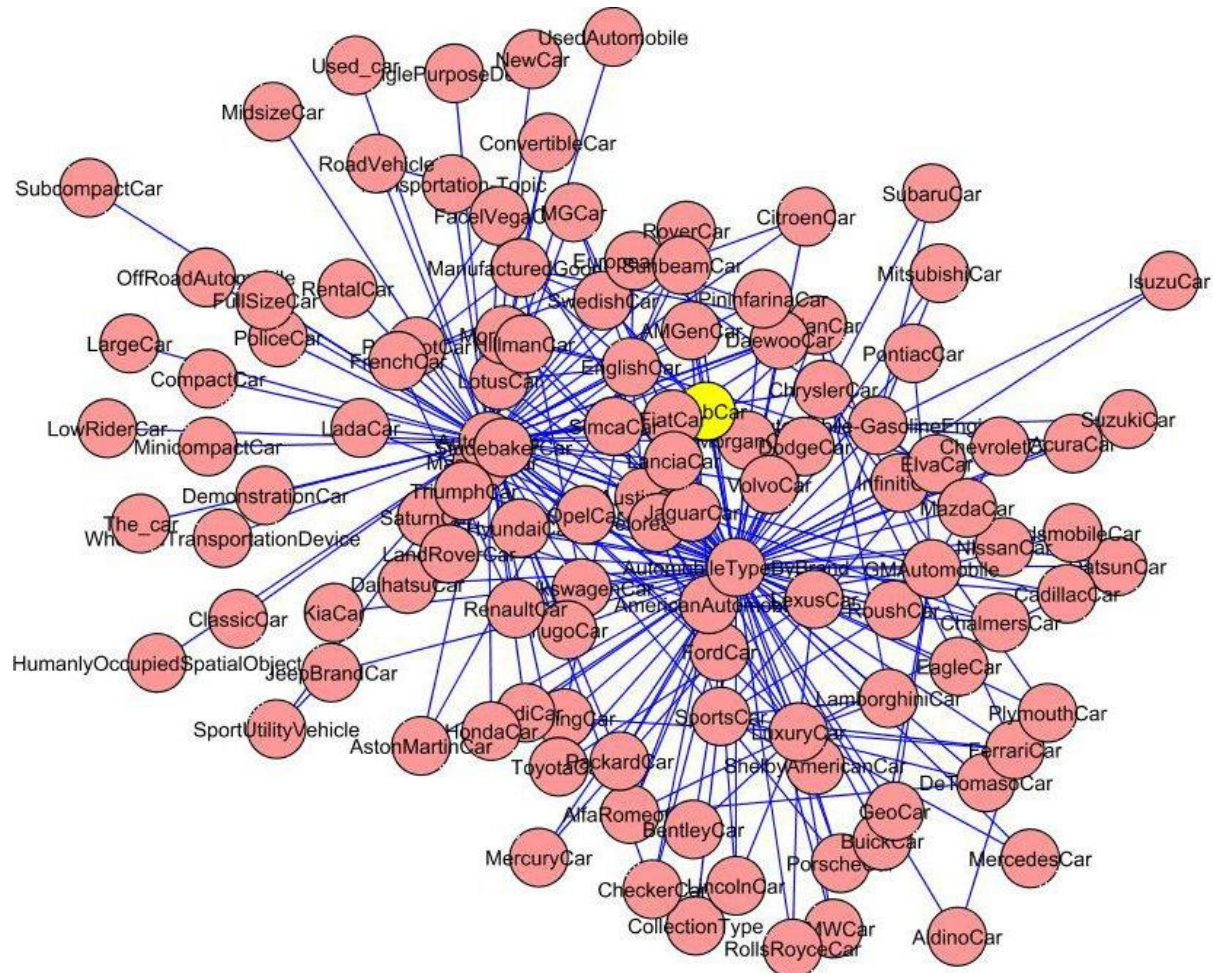

Zooming

Example: Graph of concepts

- only keep Saab neighborhood, zoom in more

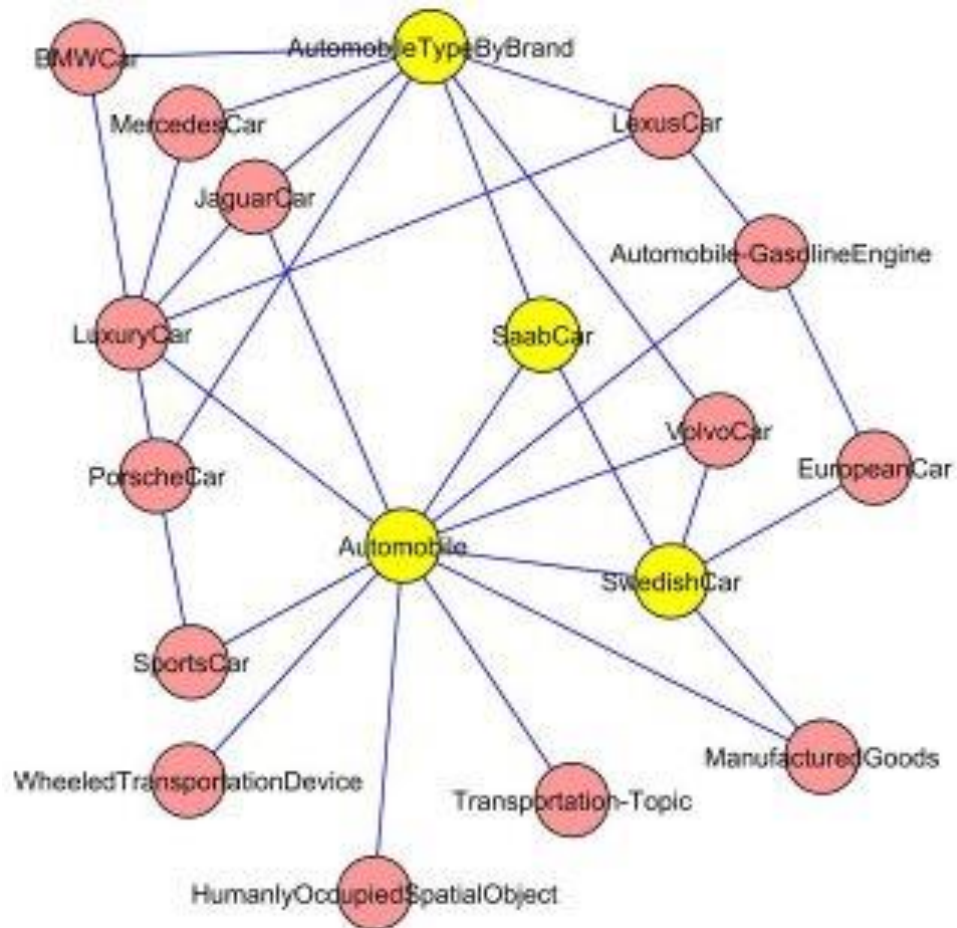

Aggregate

As discussed, good ways to aggregate all data into a single display are:

- biplots (project all data into a PCA vector basis)
- multidimensional Scaling (MDS)
- parallel coordinates

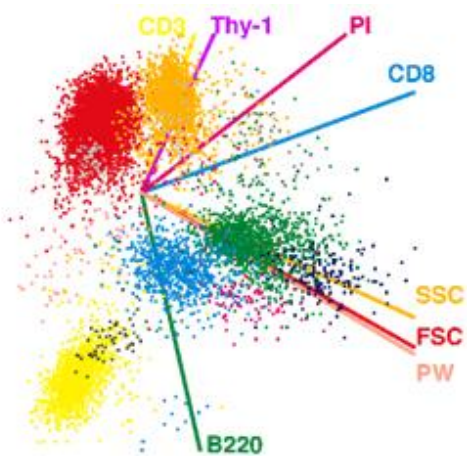

biplot

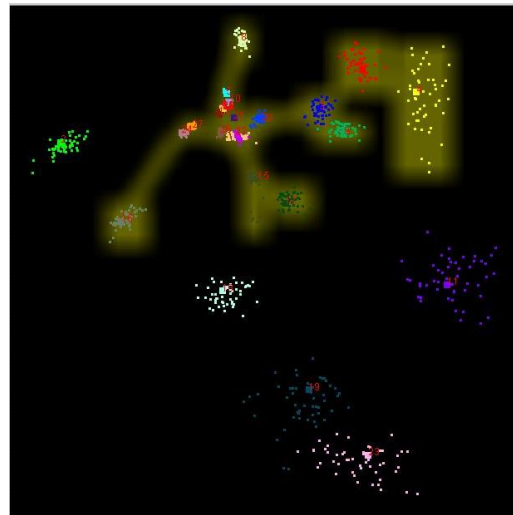

MDS

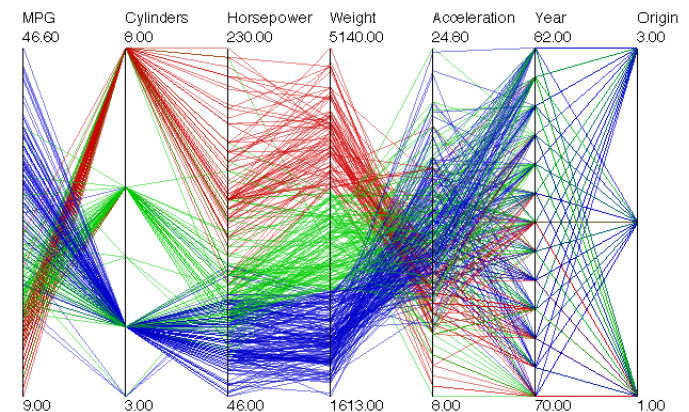

parallel coordinates

Overview and Detail

The Visual Information-Seeking Mantra

- devised 1996 by Ben Shneiderman (U Maryland, College Park)
- summarizes many visual design guidelines
- in some ways inspired by human vision/behavior
- provides an excellent framework for designing Information visualization applications.



Overview, zoom and filter, then details-on-demand

....

Overview, zoom and filter, then details-on-demand

Overview, zoom and filter, then details-on-demand

Overview, zoom and filter, then details-on-demand

Overview, zoom and filter, then details-on-demand

Overview and Detail

Information space overview plus some detail

- maintains (some) context with the detail currently focused on

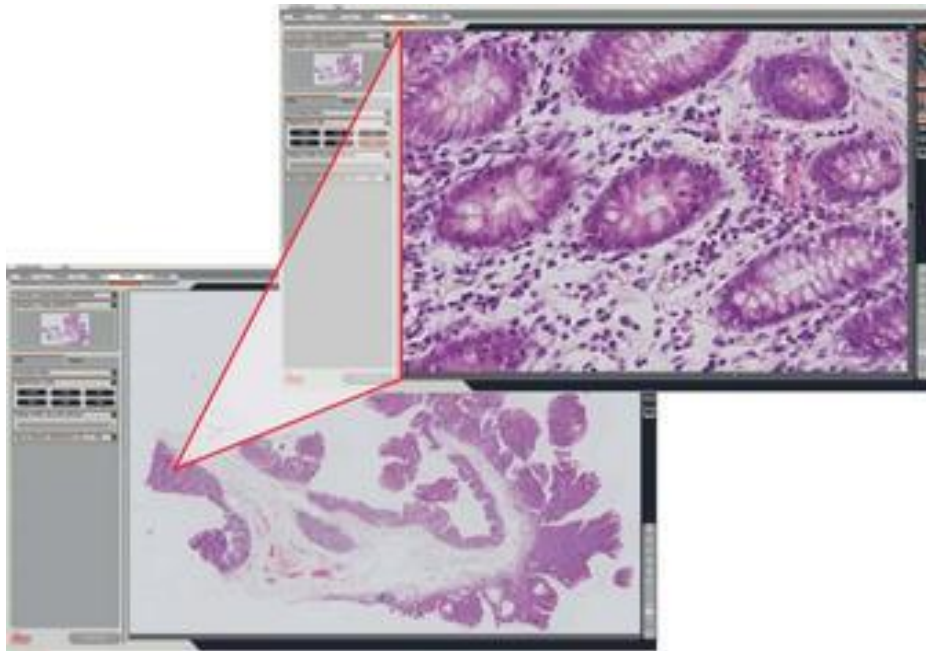

Leica Microsystems

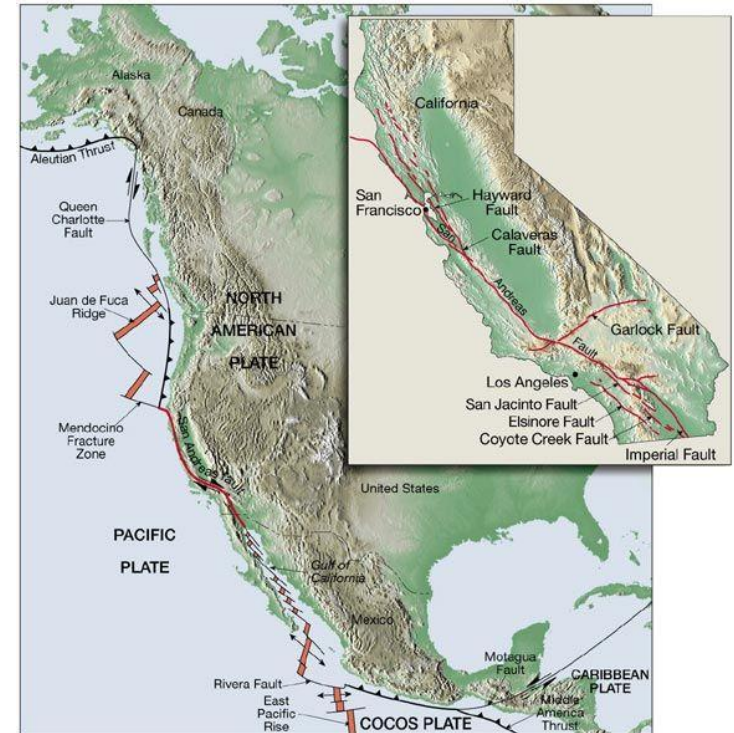

WikiViz

Focus + Context

Overview and detail

- disjoint views, maybe connected by a fan
- but: they simultaneously shows both overview and details
- require the viewer to consciously shift his/her focus of attention

Focus + context

- one single view which shows information in direct context
- maintains continuity across the display
- do not require viewer to shift back and forth
- a good F+C paradigm is the *lens*
- but: there will be distortion

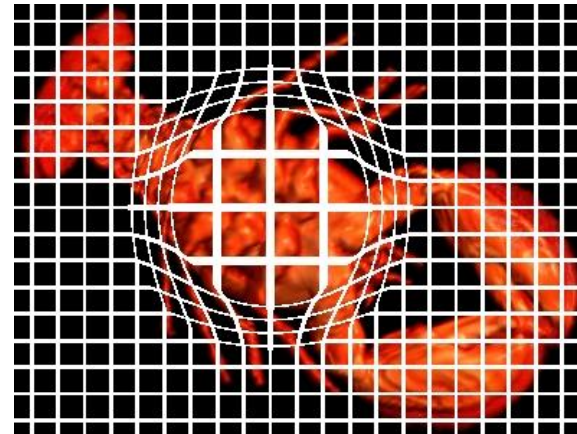
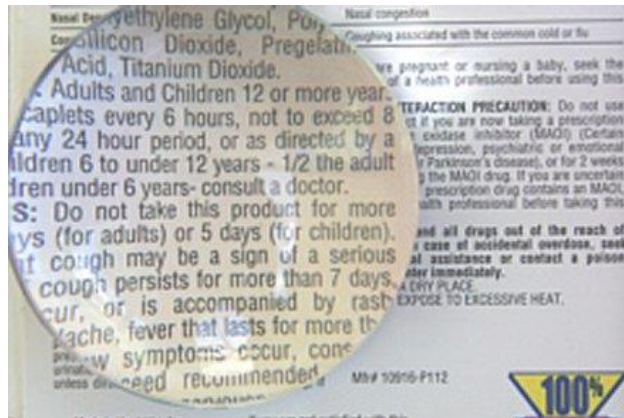

Fisheye Lenses

Fisheye lenses

- physically correct and therefore familiar
- keep target item in focus
- less relevant peripheral items are dropped or reduces in size
- distortion

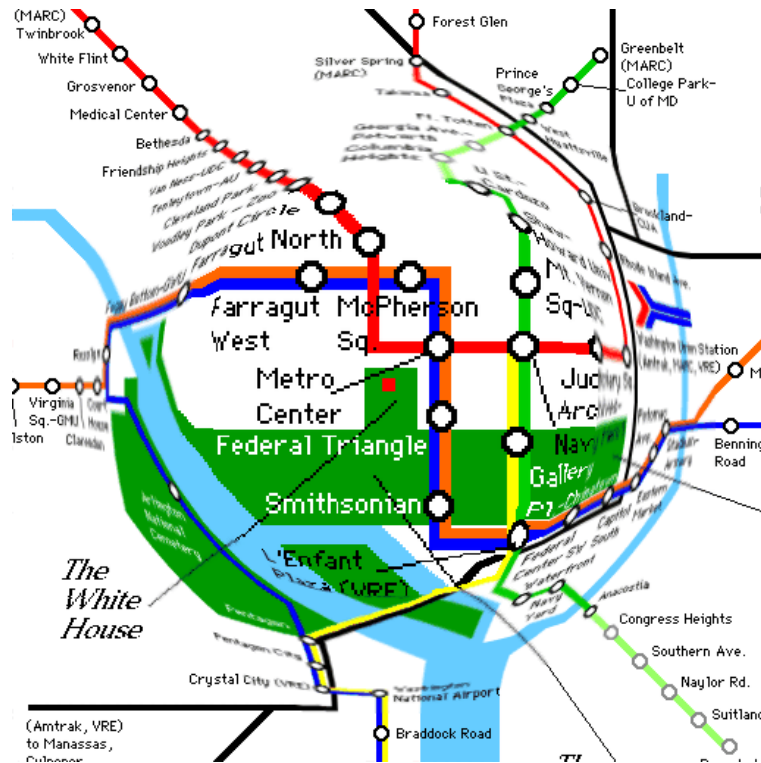

Bifocal Lens

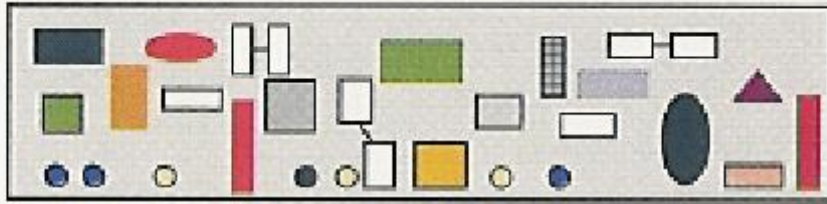

Complete Mapped Information Space

fold

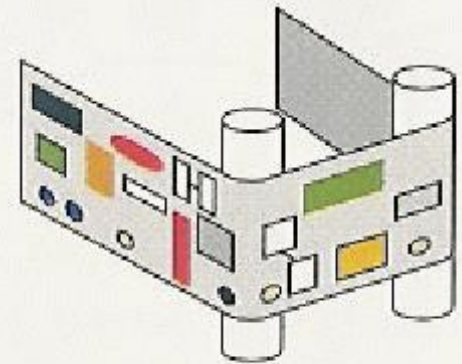

Principle of the Bifocal Display

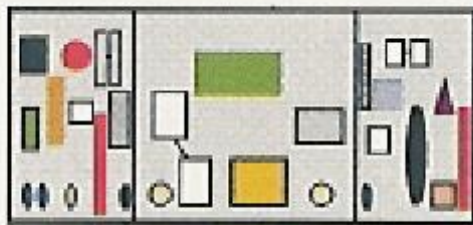

Bifocal Display Seen by the User

project



Bifocal Lens

London subway map



(Volumetric) Magnification Lenses

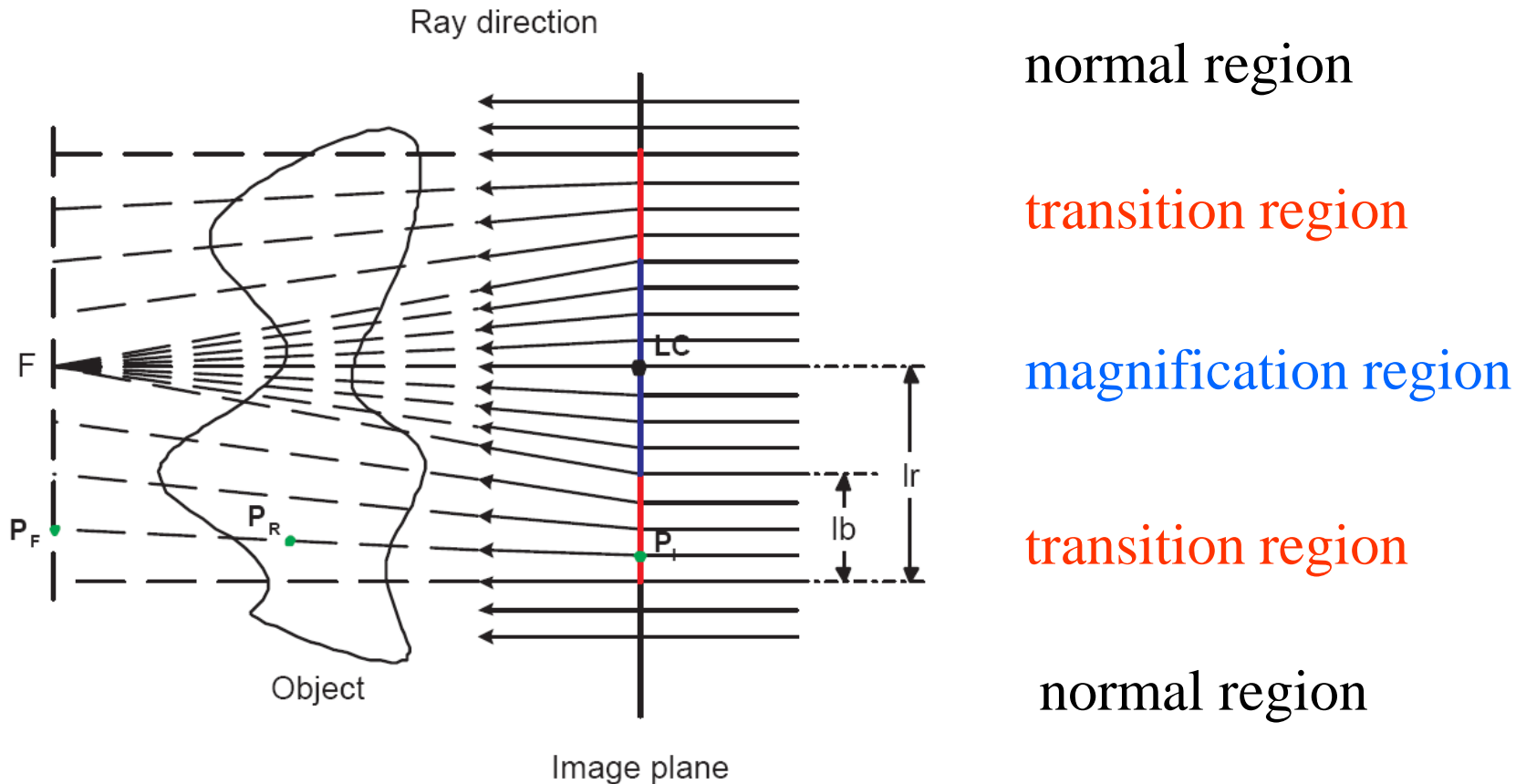

Avoid aliasing in transition regions by low-pass filtering

Generalized Lenses

Computers can go beyond (stretch) the laws of physics

- example: multi-perspective lens rendering, gaze-directed, ...

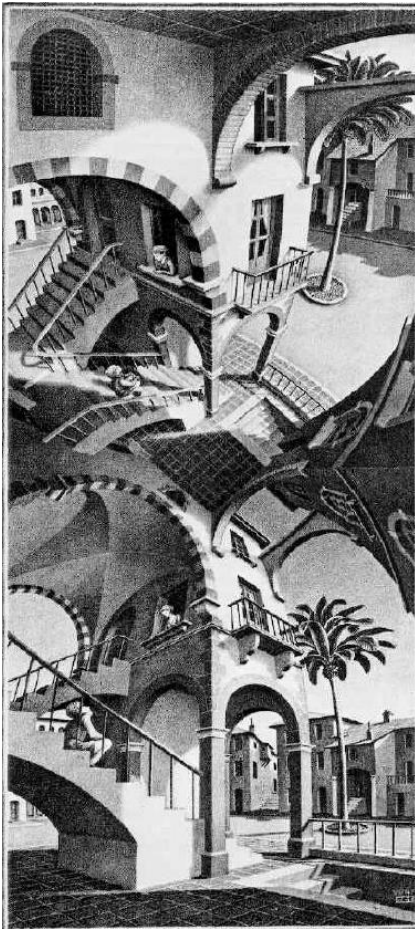

Rademacher/Bishop

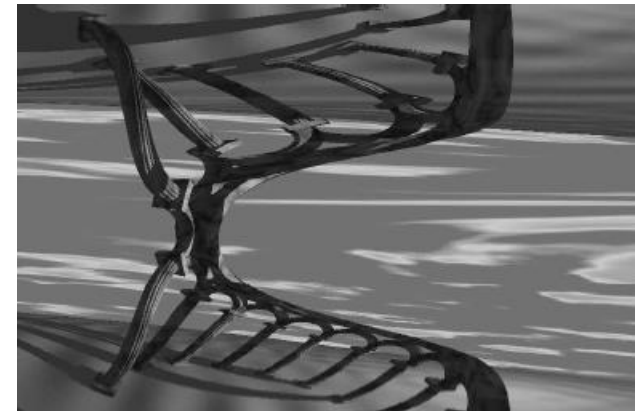
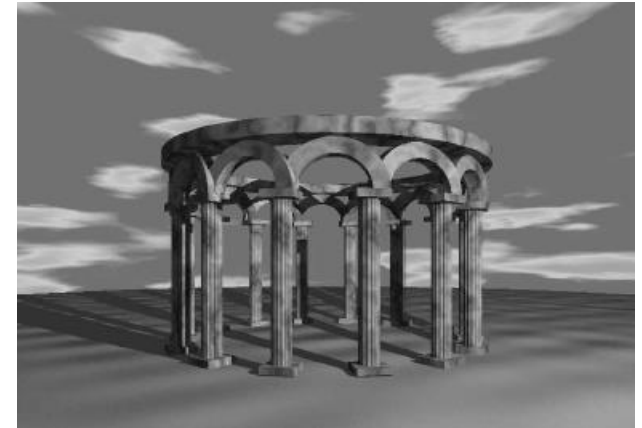

MC Escher

Loeffelmann/Groeller

Generalized Lenses

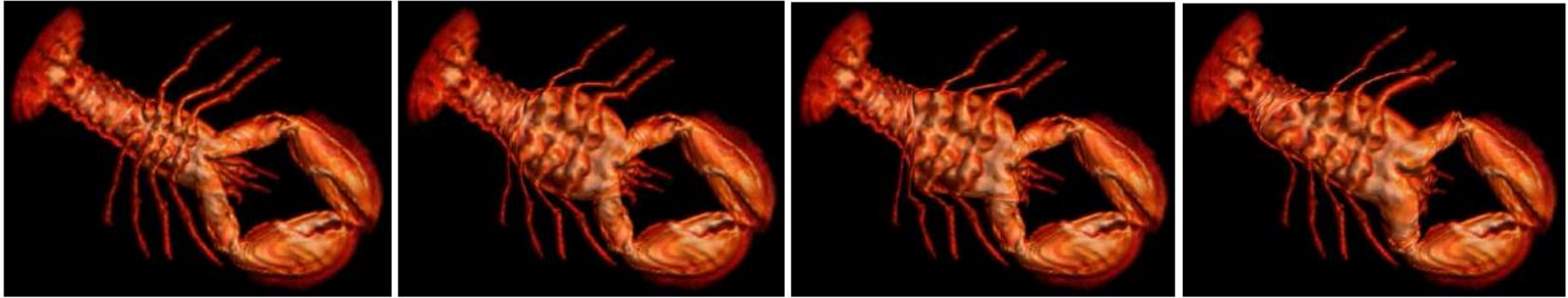

no lens

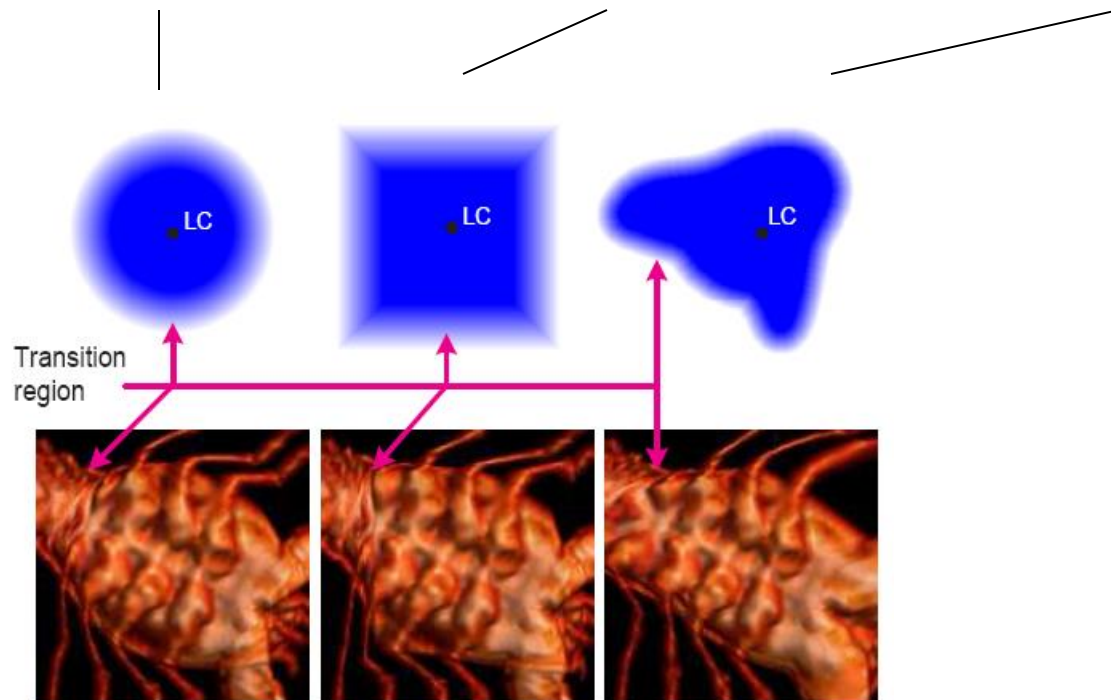

Wang et al., 2005

Lenses in Information Visualization

Hyperbolic Tree fisheye lens

- Xerox PARC/Inxight
- selectively and smoothly reduce complexity as user focus changes

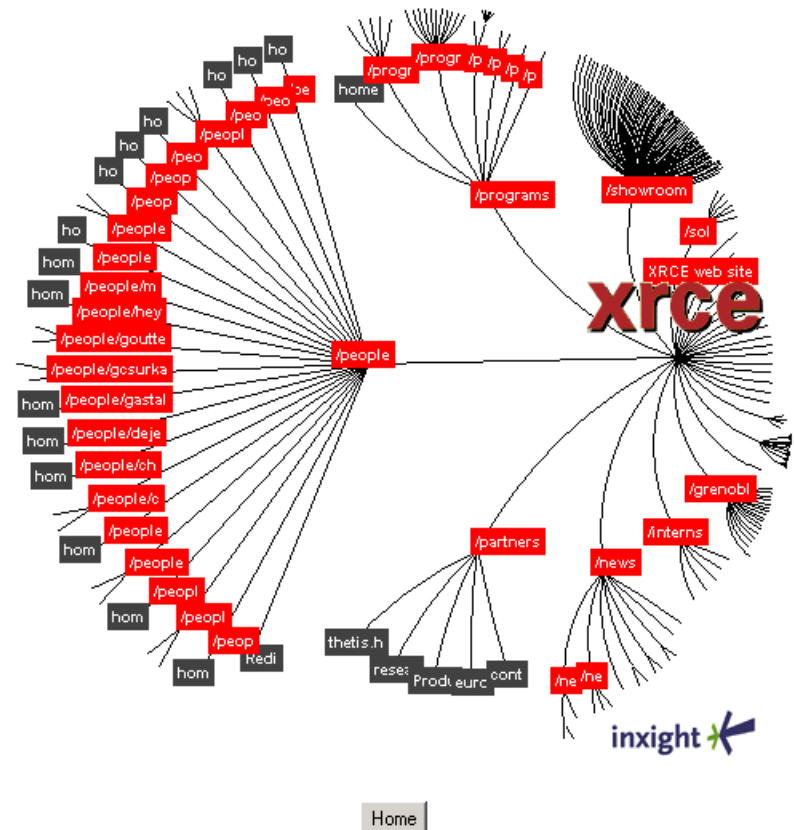
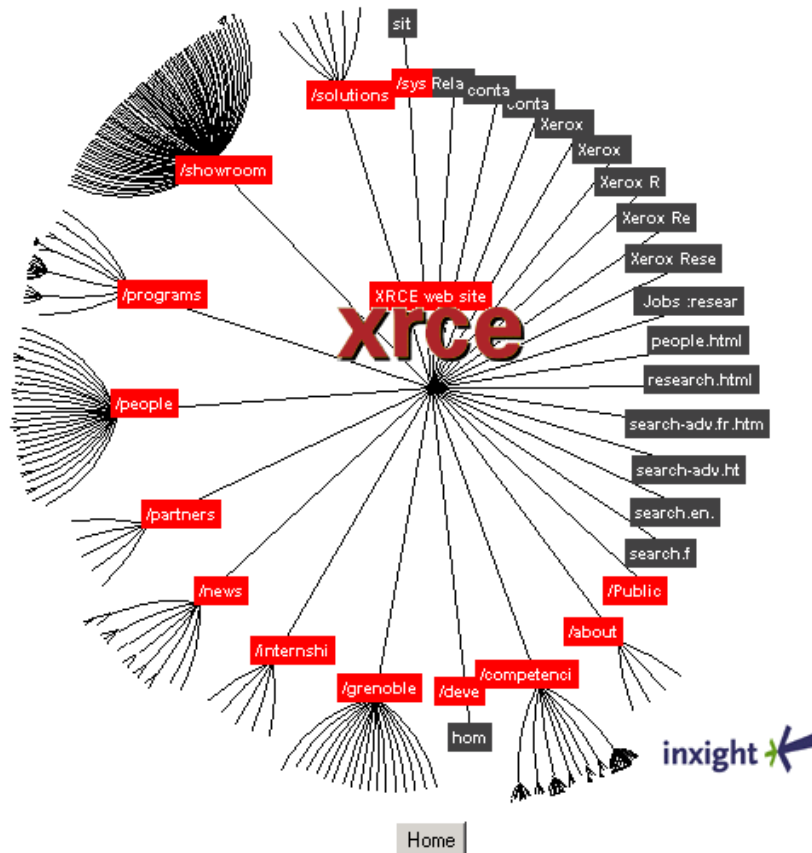

Lenses in Information Visualization

Table Lens (Rao and Card, 1994)

- uses a DOI (degree of interest) lens
- fuses symbolic and graphical detail driven by the DOI lens

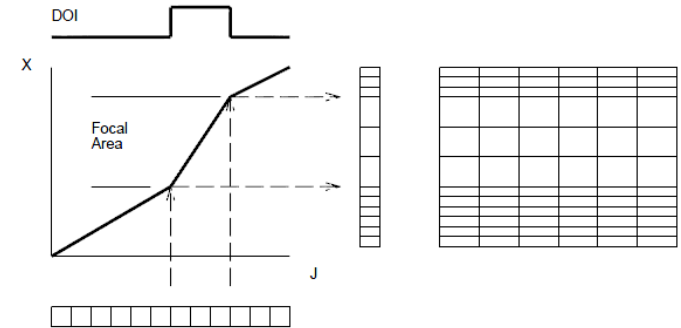

Table Lens: Baseball Player Statistics

Calculate: "Hits" / "At Bats" = "Avg"

	Avg	Career Avg	Team	Salary 87
Larry Herndon	0.24734983	0.27282876	Det.	225
Jesse Barfield	0.2886248	0.27268818	Tor.	1237.5
Jeffrey Leonar	0.27859238	0.27260458	S. F.	900
Donnie Hill	0.28318584	0.2725564	Oak.	275
Billy Sample	0.285	0.2718601	Atl.	NA
Howard Johnson	0.24545455	0.25232068	N. Y.	297.5
Andres Thomas	0.250774	0.2521994	Atl.	75
Billy Hatcher	0.25775656	0.25211507	Hou.	110
Omar Moreno	0.2339833	0.2518029	Atl.	NA
Darnell Coles	0.2725528	0.25153375	Det.	105

Row 304: Mike Lavalliere; Column 20: Put Outs Value: 468 810 -- 2163

Lenses in Information Visualization

Perspective Wall

- Xerox PARC/Inxight
- details on the center panel are at least three times larger than the details on a flat wall that fits the field of view

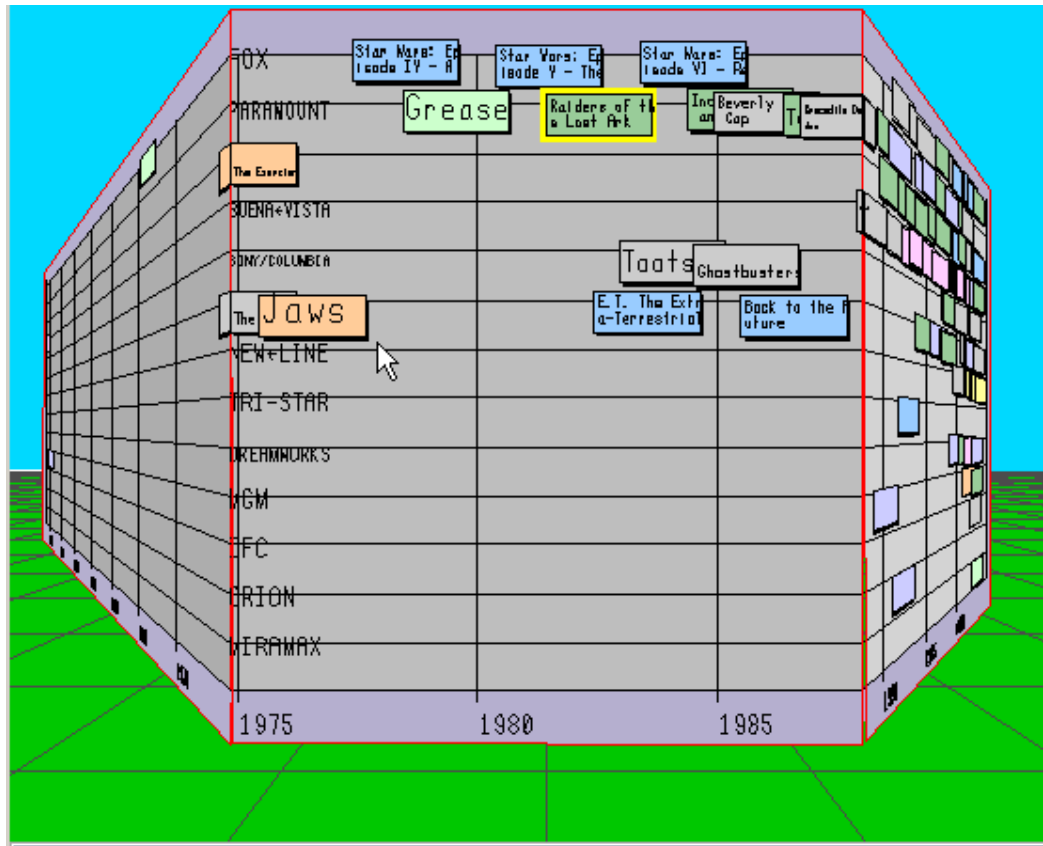

Magic Lens

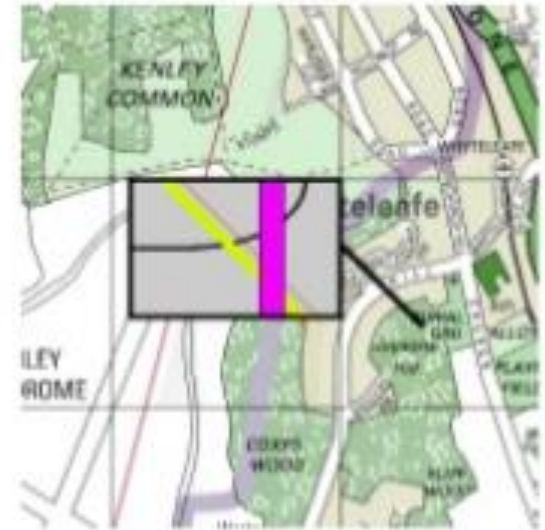
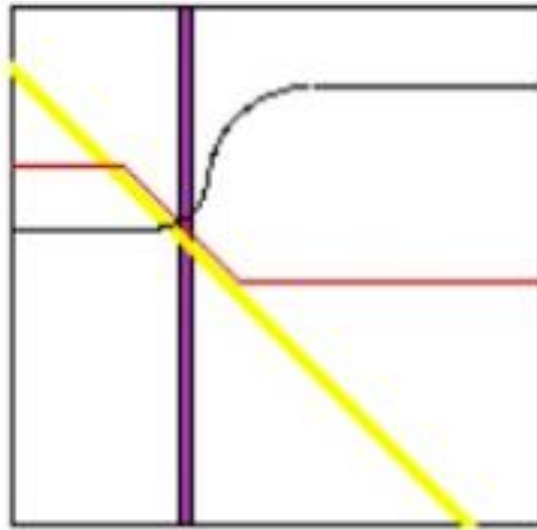

Illustrating the concept of a magic lens. (a) shows a conventional map of an area, (b) shows the location of services (gas, water and electricity pipes) in the same area, and (c) a (movable) magic lens shows services in an area of interest, in context

[Video](#)

Magic Lens Video



Zoom and Pan

Panning

- smooth movement of a viewing frame over a 2D image of greater size
- Zooming
 - increasing magnification of a decreasing fraction (or vice-versa) of a 2D image under the constraint of a viewing frame of constant size

Transfer of the focus of attention:

- zoom out → pan → zoom in

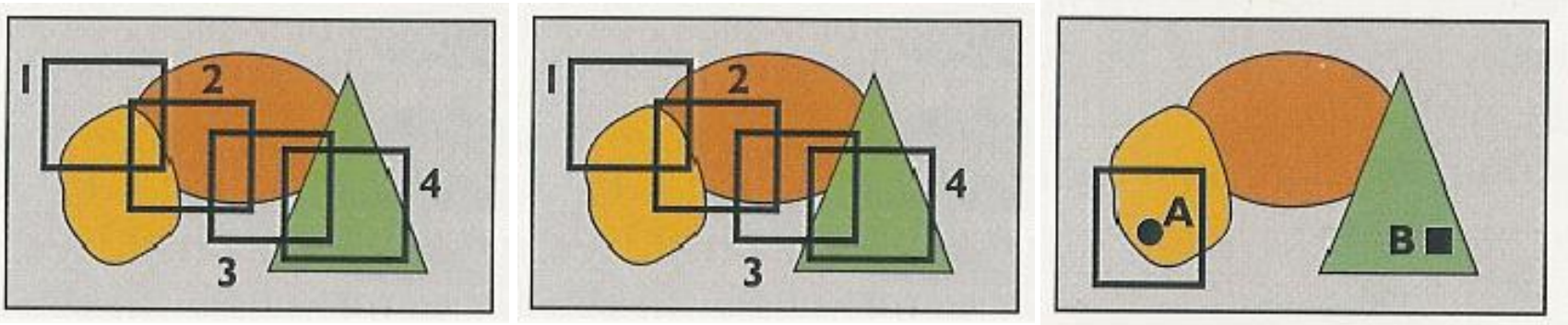

Scale-Space Diagrams

Efficient transfer of the focus of attention:

- zoom out → pan → zoom in

Furnas, Bederson, 1995

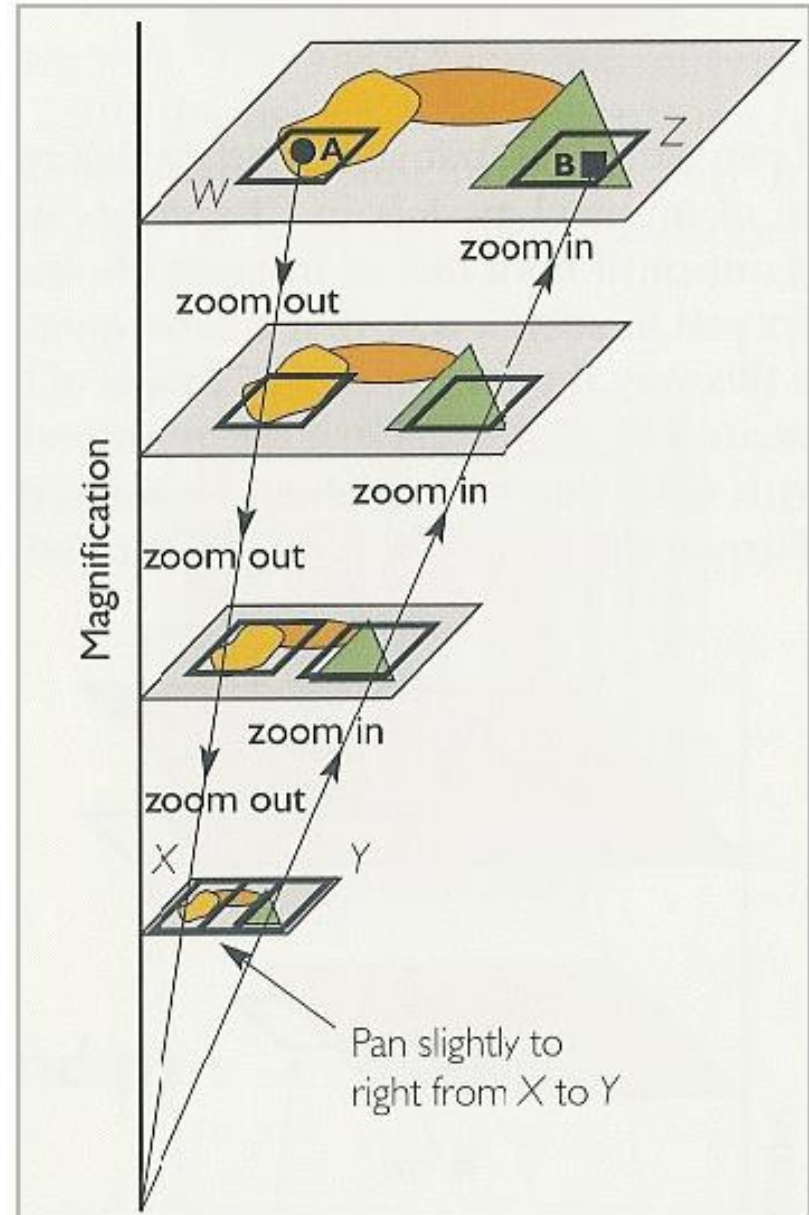

Scale-Space Diagrams Demo Video

Intelligent Zooming

Depending on scrolling speed, zoom more or less

- allows efficient navigation of large documents
- employs semantic zooming

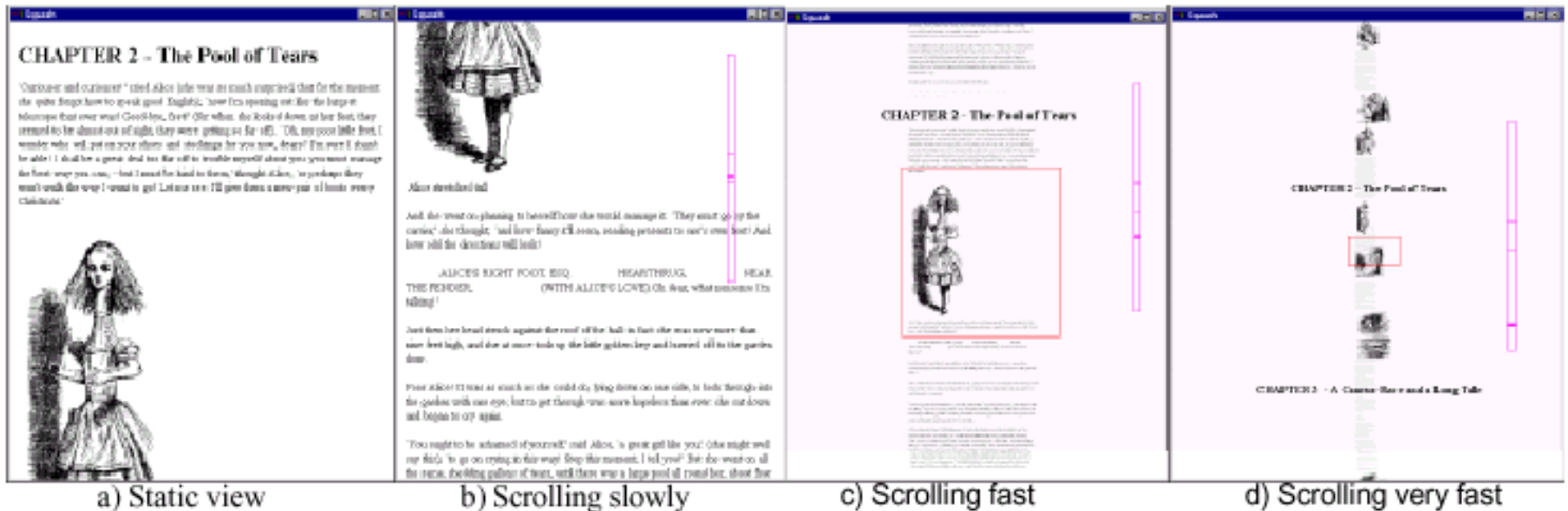

Igarashi, Hinckley, 2000

Semantic Zoom

Standard zoom:

shows a down/up scaled version of the object/image

Semantic zoom:

- shows a different representation determined by the space available

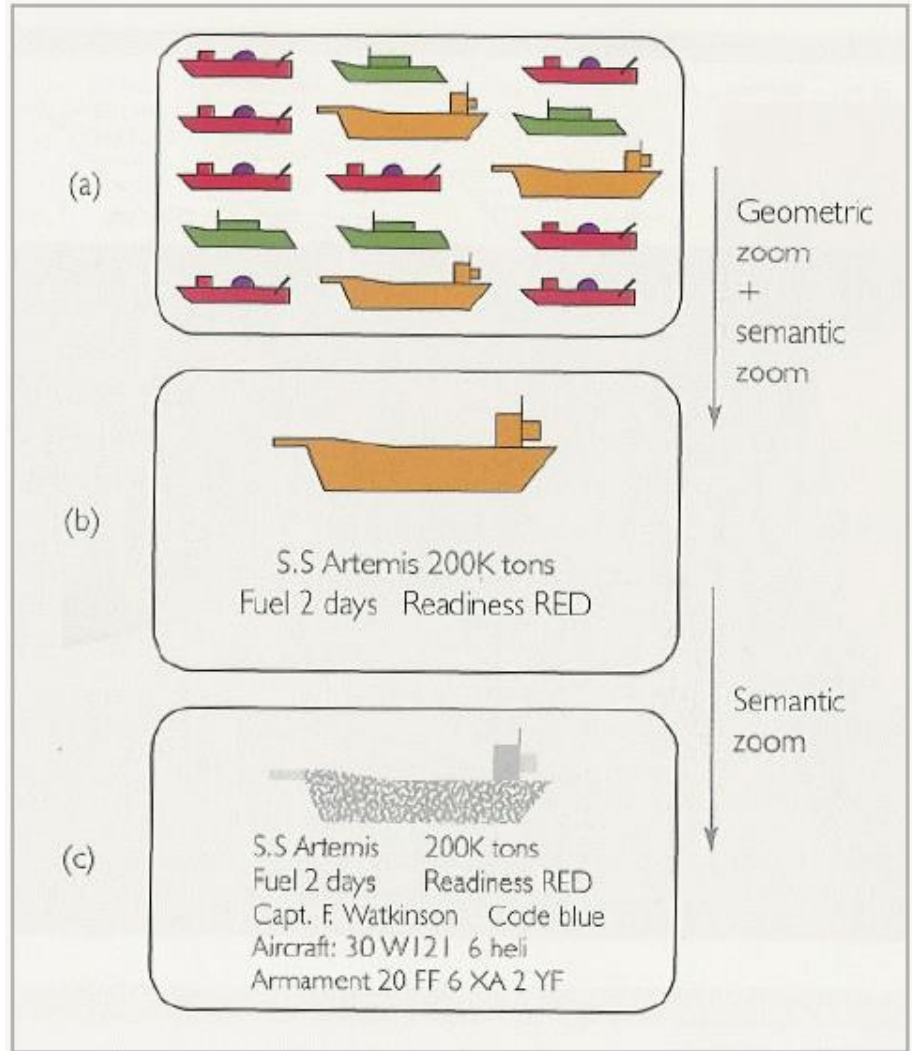

Semantic Zooms: Maps



Semantic Zooms: Information Visualization

Could show different levels/aspects of information

- on a map, show either parking lots, bars, or restaurants
- zoom in by price range (cheap first, then more expensive...)
- zoom in by preference (favorite food first, then less favorite...)
- may combine these criteria into a preference function

Semantic Zooms: Information Visualization

Could show different levels/aspects of information

- on a map, show either parking lots, bars, or restaurants
- zoom in by price range (cheap first, then more expensive...)
- zoom in by preference (favorite food first, then less favorite...)
- may combine these criteria into a preference function

Zoom levels may require access rights

- members only
- big wallets only
- classified information

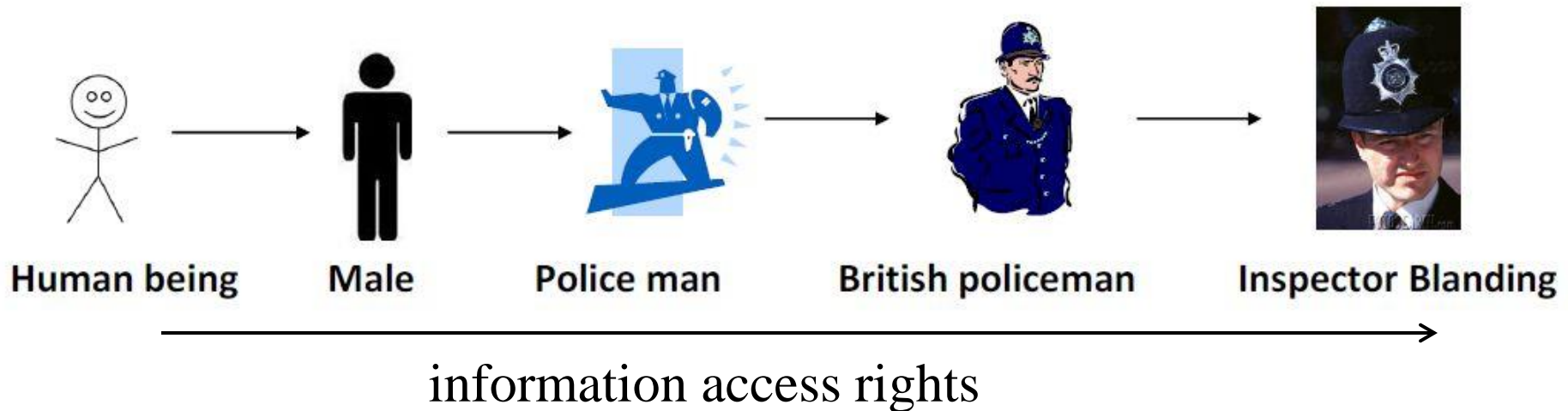

Exploded Views

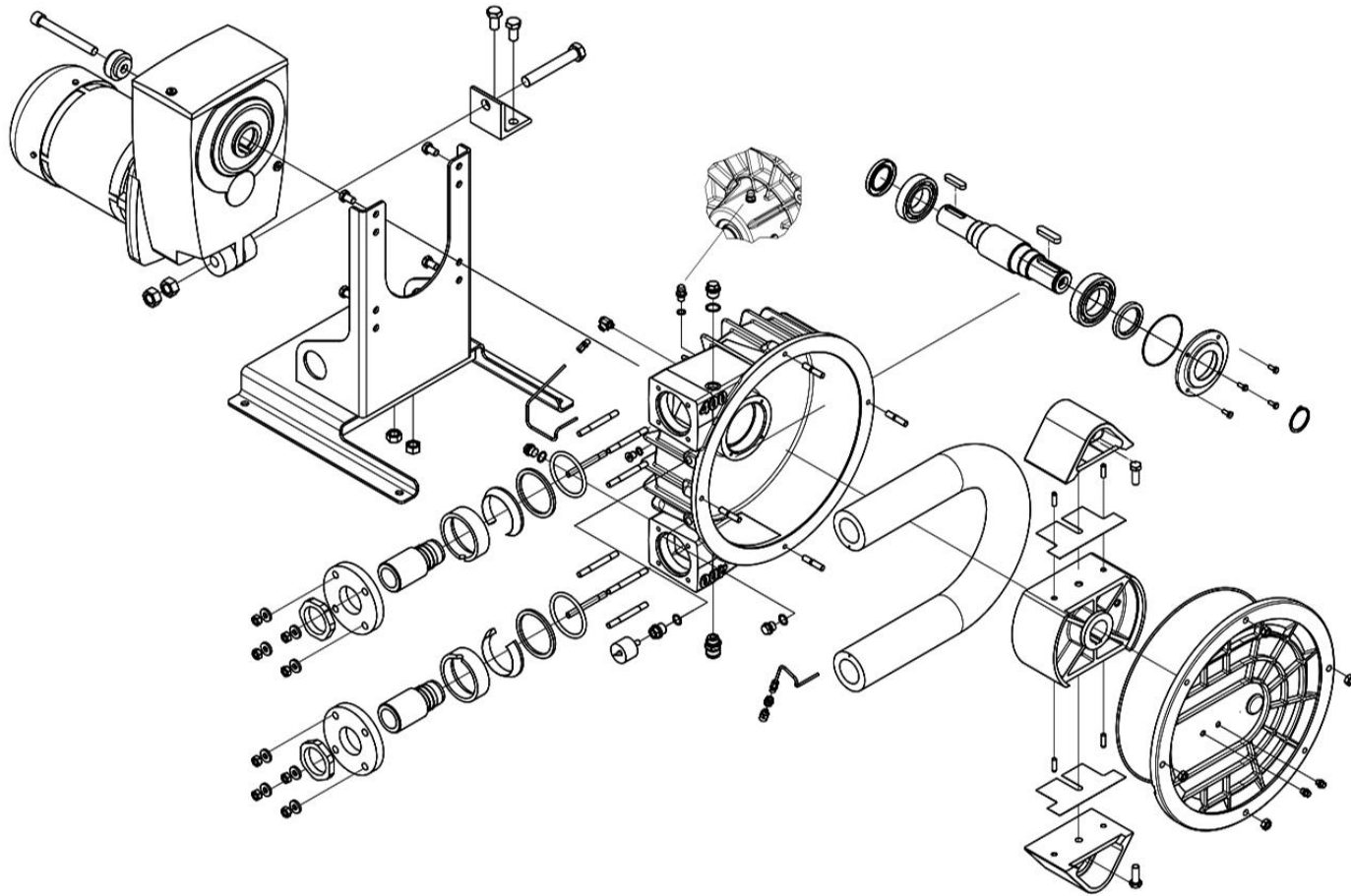

[Video](#)

An Exploded View Paradigm to Disambiguate Scatterplots

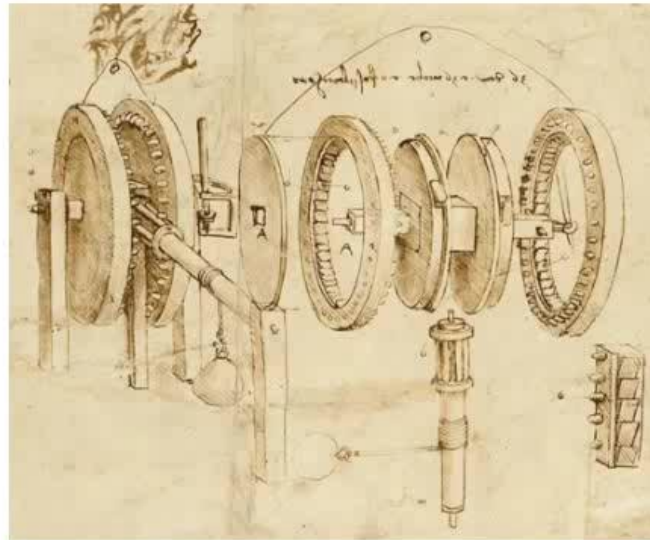

Brushing and Linking

Interactive technique

- Highlighting
- Brushing and Linking

At least two things must be linked together to allow for brushing

- select a subset of points
- see the role played by this subset of points in one or more other views

Example systems

- Graham Will's EDV system
- Ahlberg & Sheiderman's IVEE (Spotfire)

Baseball Data: Scatterplots and Histograms and Bars

how long
in majors

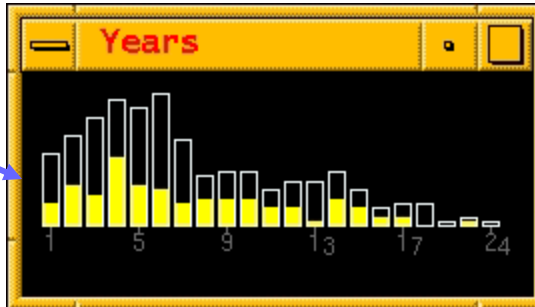

similarly
distributed
salaries

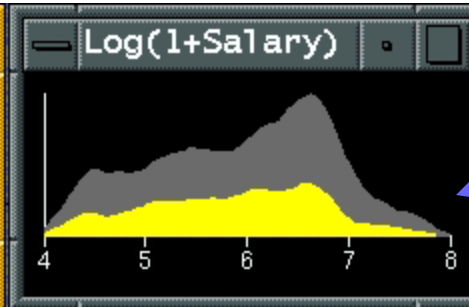

avg. assists (x)
vs.
avg. putouts (y)
(fielding ability)

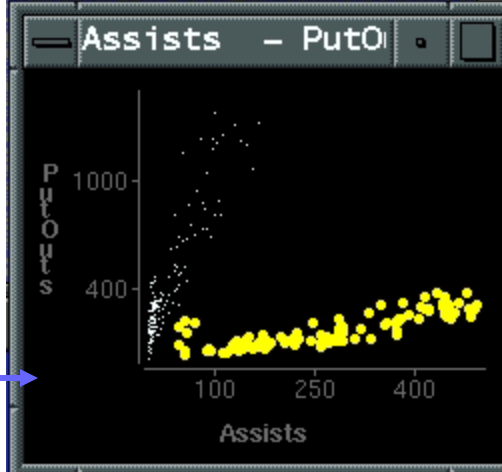

avg. career
home runs (y)
vs.
avg. career hits (x)
(batting ability)

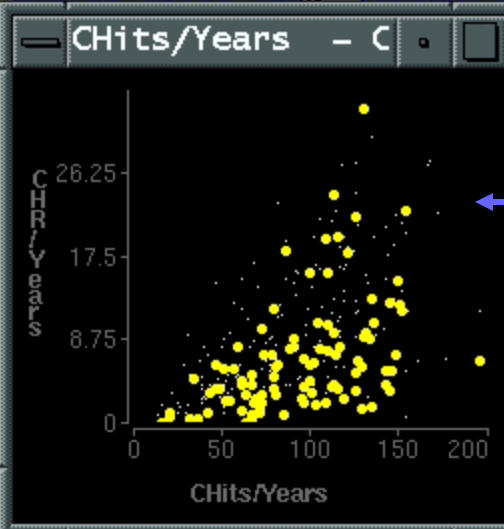

(pick assists pref.)

distribution
of positions
played



anything interesting?

Baseball Data: Scatterplots and Histograms and Bars

how long
in majors

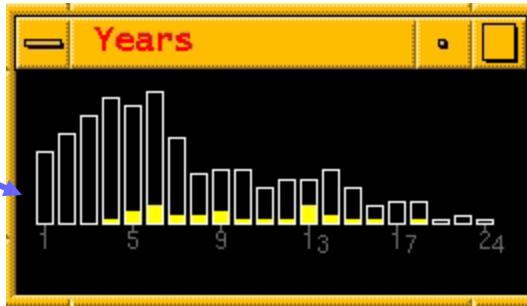

select high
salaries

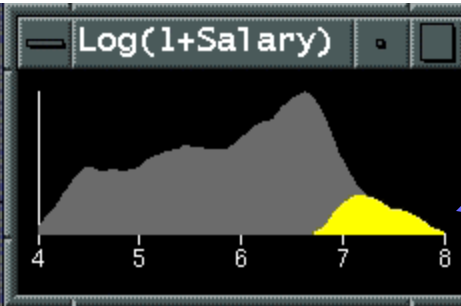

avg. assists (x)
vs.
avg. putouts (y)
(fielding ability)

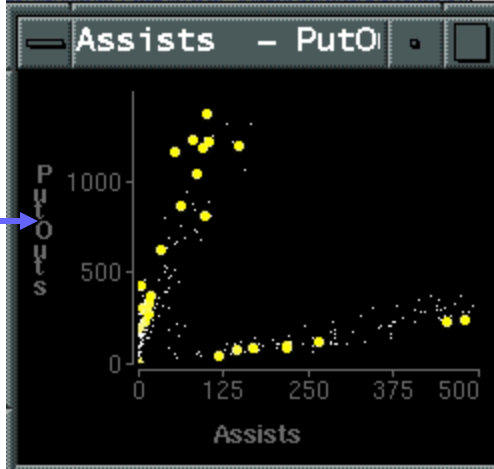

avg. career
home runs (y)
vs.
avg. career hits (x)
(batting ability)

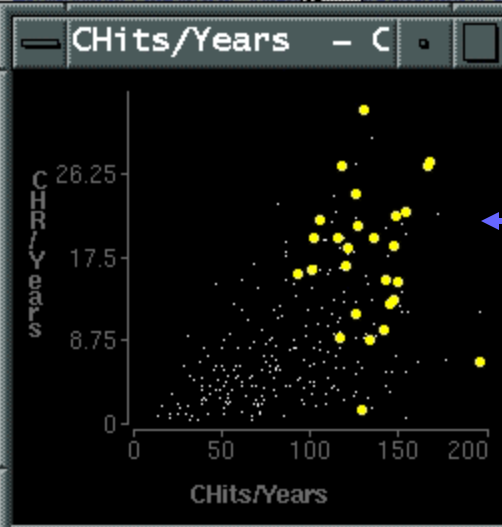

distribution
of positions
played



anything interesting?

What was Learned from Interaction w/ the Baseball Data?

- Seems impossible to earn a high salary in the first three years
- High salaried players have a bimodal distribution (peaking around 7 & 13 yrs)
- Hits/Year a better indicator of salary than HR/Year
- High paid outlier with low HR and medium hits/year. Reason: person is player-coach
- There seem to be two differentiated groups in the put-outs/assists category (but not correlated with salary) Why?

Dashboard Brushing/Linking Example



[video](#)

Brushing: Highlighting

Use mouse interaction to highlight points and lines in

- parallel coordinates
- scatterplots

